

# ROBUS®

QUALITY PRODUCTS BY LED GROUP

## Stainless steel outdoor

## GU/GZ10 wall light

### R235-13

Please read instructions before commencing installation and retain for future reference.

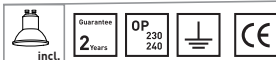

#### Specification:

Outdoor wall mounted stainless steel (18%Ni, 10%Cr) fitting for GU10 or GZ10 cap lamps in steel finish

Electric shock protection:	Class 1 (Must be earthed!)
Lamp types:	max 240V 35W GU10/GZ10 cap
Dimensions:	R235-13
Height	150mm
Projection	120mm
Weight:	0.8Kg approx
Body diameter	62mm
Ingress Protection:	IP44

Recommended Mounting: on a wall min 2.3m above ground level  
Minimum distance from illuminated object is 50cm  
Complies with EN60598 (BS4533)

#### Installation:

! Electrical products can cause death or injury, or damage to property. If in any doubt about the installation or use of this product, consult a competent electrician.

! Ensure that mains supply is off before commencing work

1. Remove plastic base from fitting by opening domed nuts.
2. Fix plastic base securely to the wall
3. Connect supply cables to terminals block, Brown (live) to L, Blue (neutral) to N and Green/yellow to Earth. Seal cable entry with sealant and reattach fitting to the base, tightening the nuts securely to ensure base is watertight
4. Unscrew body & insert 35W lamp. Replace securely to avoid water ingress

! **Attention:** Fitting becomes hot quickly. Switch off and allow to cool before servicing

#### Stainless Steel Fittings – Maintenance Instructions

This stainless steel product has been given a transparent oven-baked glaze that provides extra protection against atmospheric agents. Despite this, blotches may appear on the surface of the stainless steel. They can be removed by a soft cloth soaked with neutral oil (WD-40 or equivalent).

**Note:** - If the product is exposed to very corrosive environmental conditions (sea fronts, salty atmospheres etc) it will require additional maintenance. Before installing, the stainless steel parts must be treated with neutral oil, which must penetrate all the joints. After treatment, dry with a soft cloth. In very corrosive environments, the treatment with oil must be repeated at least 4 times a year. In cases of serious corrosion use an abrasive paste (specifically designed for stainless steel or chrome) to remove the stain and then apply the neutral oil again.

**The Installation must be carried out by an electrician**

LED Group  
Western Retail Park  
Nangor Road  
Dublin 12  
Ireland

Tel: +353 1 7099000  
Fax: +353 1 7099060  
Email: info@led.ie  
Website: www.led.ie



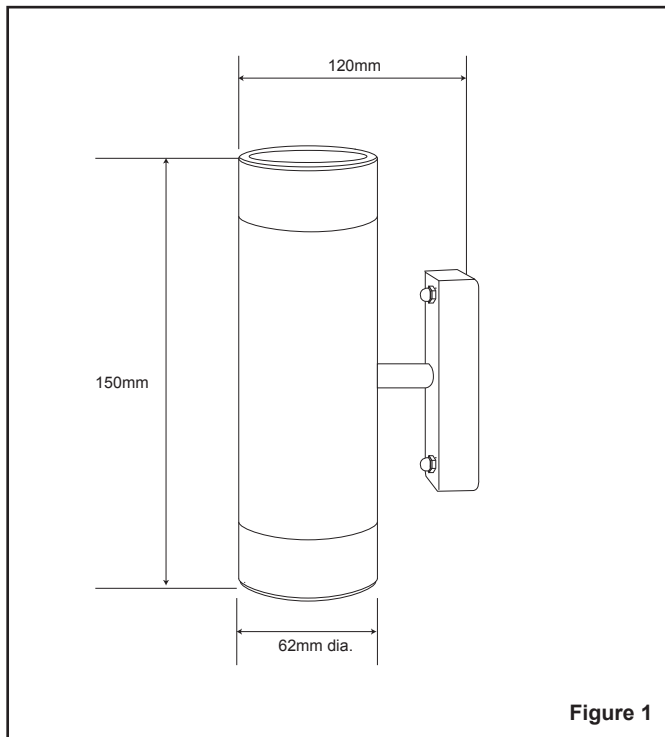

Figure 1

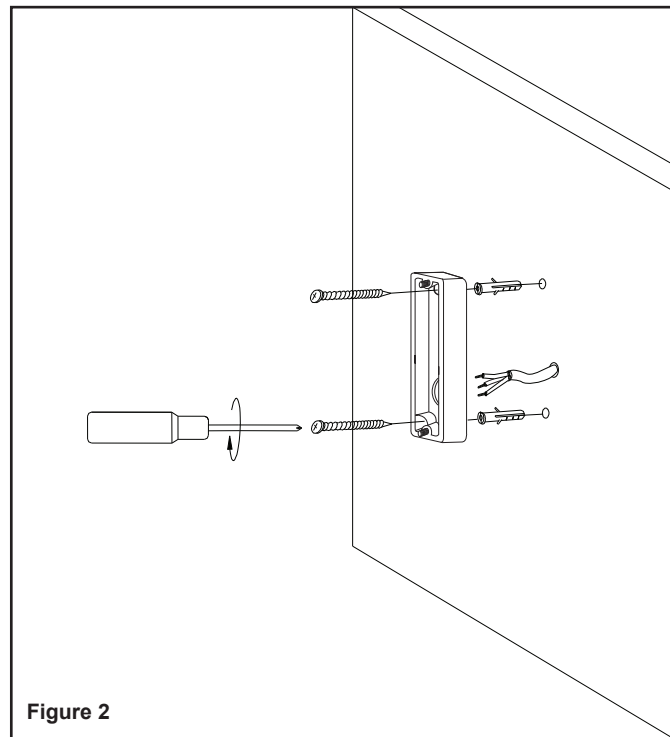

Figure 2

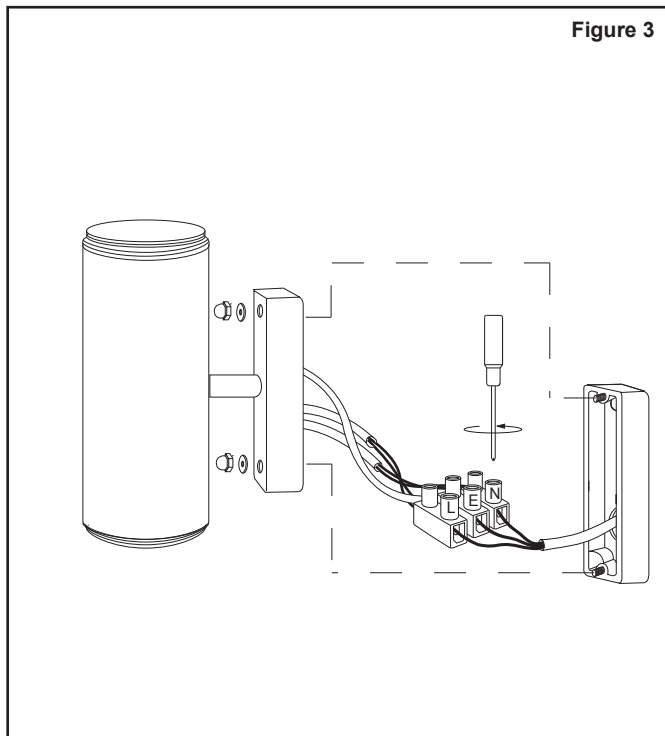

Figure 3

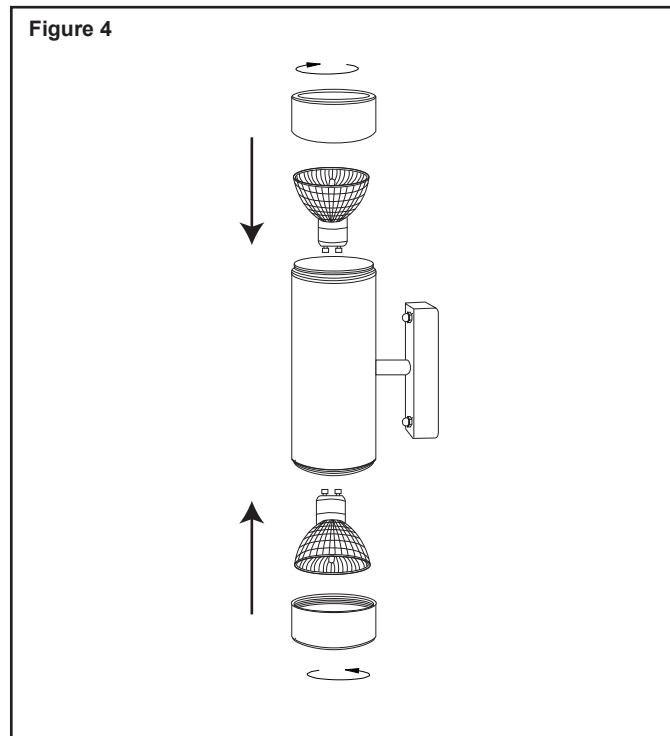

Figure 4

### Information for the Product user

1. Please note the requirement to dispose of Waste Electrical & Electronic Equipment separately from household waste (WEEE marked with crossed out wheelie bin symbol).
2. Please consider your role in contributing to re-use and recycling by returning this product at end of life to a collection centre for waste electrical equipment or a Civic Amenity site, or to a retail outlet from which you are purchasing a replacement.
3. This equipment may contain substances that are hazardous to health and the environment if disposed of carelessly. It is important that it is separated from normal household waste and recycled in the WEEE chain
4. The "crossed out wheelie bin symbol" on a product indicates this equipment must not be disposed of in normal household waste, but should be disposed of according to local WEEE regulations

**The Installation must be carried out by an electrician**

LED Group  
Western Retail Park  
Nangor Road  
Dublin 12  
Ireland

Tel: +353 1 7099000  
Fax: +353 1 7099060  
Email: info@led.ie  
Website: www.led.ie

