

ROBUS®

QUALITY PRODUCTS BY LED GROUP

Motion detector 360° PIR surface

R360N

Please read instruction before commencing installation and retain for future reference.



Specification:

Passive infra-red sensor switch for lighting energy saving applications, ceiling mounted indoor use only.

Electrical Protection:	Class II
Supply:	220-240V 50/60Hz
Output load:	Max. 1000W incandescent lamp, 300W fluorescent, 150W LED
Operating Temp:	5°C < ta < 25°C
Dimensions:	Diameter: Ø110mm, Depth: 40mm, Projection: 45mm
Weight:	0.24Kg
Detection range:	360° detection angle, 10m motion, 2.8m Mounting height
Time Delay:	Adjustable time delay 10 seconds ~16 minutes
Light Level Adjustment:	Daylight to night adjustable
IP:	IP20

Terminals suitable for cable sizes from 0.75mm² to 1.5mm².

Suitable for mounting on normally flammable surface

Note:

Product technical information and specification may change over time without prior notification. For the latest technical information please visit our web site www.ledgrouprobust.com or www.robustdirect.com

Features:

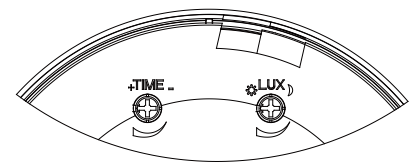
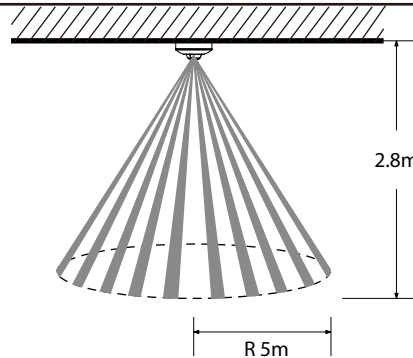

Lux, time adjustable

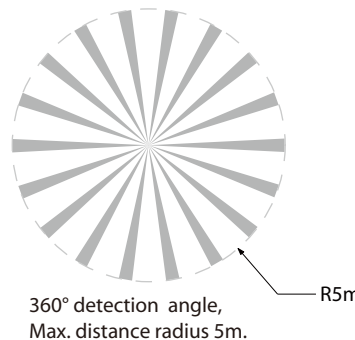

360° detection angle,
Max. distance radius 5m.

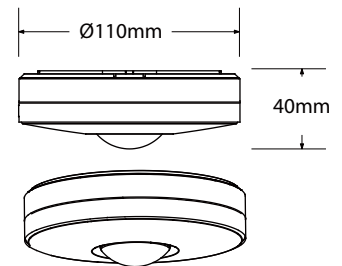

Dimensions

Information for the Product user

1. Please note the requirement to dispose of Waste Electrical & Electronic Equipment separately from household waste (WEEE marked with crossed out wheelee bin symbol).
2. Please consider your role in contributing to re-use and recycling by returning this product at end of life to a collection centre for waste electrical equipment or a Civic Amenity site, or to a retail outlet from which you are purchasing a replacement.
3. This equipment may contain substances that are hazardous to health and the environment if disposed of carelessly. It is important that it is separated from normal household waste and recycled in the WEEE chain
4. The "crossed out wheelee bin symbol" on a product indicates this equipment must not be disposed of in normal household waste, but should be disposed of according to local WEEE regulations

The Installation must be carried out by an electrician

LED Group
Western Retail Park
Nangor Road
Dublin 12
Ireland
Issue 2 110414

Tel: +353 1 7099000
Fax: +353 1 7099060
Email: info@led.ie
Website: www.led.ie



Features:

ADJUSTING THE LUX CONTROL LEVEL:

The Lux control module has a built-in sensing device (CdS photocell) that detects daylight and darkness.

(☀) position denotes that the lamp(s) (load) will be turned on by PIR during day and night.

(🌙) position denotes that the lamp(s) (load) will be turned on by PIR only at night.

You can set to operate the unit at the desired level by adjusting the LUX knob

ADJUSTING THE DURATION TIME:

The duration time is "the length of time that the R360N switches the load 'on' after activation". The duration time can be adjusted from (10±5) seconds to (16±3) minutes. Rotating the TIME knob from (+) to (-) will reduce the duration time.

Note: Once the lamp(s) (load) has been triggered by the PIR sensor any subsequent detection will start the timed period again from the beginning.

Installation:

! Electrical products can cause death or injury, or damage to property. If in any doubt about the installation or use of this product, consult a competent electrician.

1 Ensure mains supply is switched off before commencing work.

2 Location:

a. max 2.8m above ground level

b. Avoid: positions close to exhaust gas flues, heat extraction vents, or heat sources to avoid false triggering. Also avoid pointing toward bright lights which may prevent operation (or cause hunting i.e. flashing lights on and off) when Lux level set for night operation. Do not mount on surfaces subject to vibration.

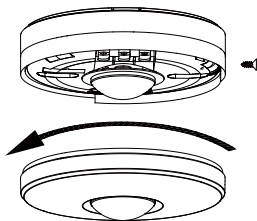

Fig 1, Remove cover moulding by undoing the front locking screw and turning anticlockwise to access the terminal block.

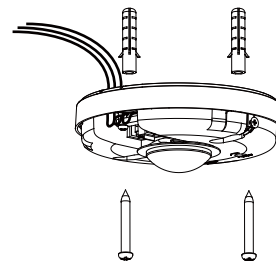

Fig 2, Drill the wall and fit the screws plugs, then fix housing to the mounting surface with mounting screws

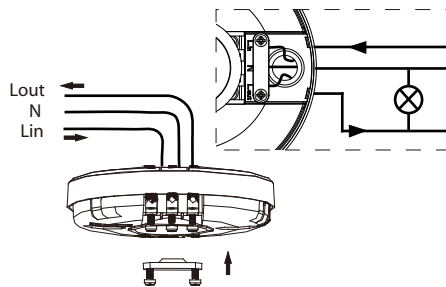

Fig 3, Connect supply cables Live, Neutral to Lin and N respectively. Connect switched Live to load to terminal marked 'Lout'.

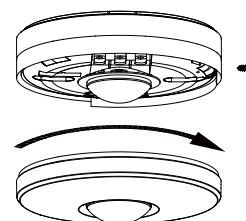

Fig 4, Refit plastic cover with mounting screw. * Switch on mains supply: The R360N will warm-up for approx 30 seconds and then switch to auto detection mode.

*Set Lux control to day position (☀) and Time to minimum (-) for initial test.

Walk testing can then be carried out to determine detection area with slow walking pace. When the detector senses movement, the load will be switched on for the preset time. When finished, set light level and delay time. Turning the Lux control toward the moon position will stop switching action during bright daylight (for energy saving). To increase on time turn time control towards +, max time delay 16 minutes. Note: once sensor has been triggered, subsequent detection restarts timing period from beginning, so light stays on until set time elapses after last triggering.

The Installation must be carried out by an electrician

LED Group
Western Retail Park
Nangor Road
Dublin 12
Ireland

Tel: +353 1 7099000
Fax: +353 1 7099060
Email: info@led.ie
Website: www.led.ie

